



OWNER'S MANUAL

FREESTYLE RM AWNING

12V MOTORIZED ROOF MOUNTED BOX AWNING
W/ DIRECT RESPONSE

RV



Before operating the awning, carefully review the Owner's Manual. The manual contains important safety information, detailed operating instructions, common maintenance procedures and other useful information.



Table of Contents

Operation	2
Manual Override	4
Awning Care	4
Fabric Care	5
Mildew	5
Pooling	5
Leaking	5
Arm Noise	6
Adjusting the Pitch	6
Carefree Major Product Limited Warranty	7

Special Note: This manual provides a basic description of the product and the standard operating controls provided by Carefree of Colorado. Some Original Equipment Manufacturers (OEM's) may alter or change the placement, style and/or functional configuration of the switches. If your controls do not match the style or description included, contact the coach manufacturer for an accurate description. OEM furnished components are not covered by the Carefree warranty.

About Carefree

From its beginning in the early 70's, Carefree of Colorado has emerged as the premier manufacturer of quality awnings and accessories for Recreational Vehicles (RVs). Our full line of products can provide the accessories that match your life style; no matter what type of RV you own. Check with your dealer to discover the products that can make your life more Carefree.

The Carefree Freestyle RM awning is state of the art with lateral support arms that provides strength and functionality without interfering with coach sidewalls, custom graphics or equipment that may be mounted on the sidewalls.

- *When retracted, the housing provides protection against the elements while the streamlined styling blends in with the RV sidewall and is a perfect complement to other Carefree products.*
- *The awnings are made with heavy duty construction including an all metal chassis.*
- *The Freestyle RM is uses Carefree's Direct Response™ system.*



This is the safety alert symbol. It is used to alert individuals to potential personal injury hazards. Obey all safety messages that follow this symbol to avoid possible personal injury or death.

 **WARNING** This product can expose you to chemicals including Di-isodecyl phthalate (DIDP), Vinyl Chloride and Formaldehyde, which are known to the state of California to cause cancer or birth defects or other reproductive harm. For more information visit www.P65warnings.ca.gov



 **WARNING** Risk of fire. Keep all sources of heat and flame away from the awning canopy. Fabric is NOT fireproof.

NOTICE Awnings are designed to provide shade and protection from the sun. The effects of wind and rain on an awning are unpredictable and can cause severe damage to the awning and/or the vehicle. If wind or extended periods of rain are expected, roll up the awning.

NOTICE It is recommended that if leaving the RV unattended for a length of time, retract the awning to avoid unexpected weather conditions.

NOTICE The Freestyle RM awning is a free-standing (self-supporting) lightweight awning with auto retraction. Do not hang items from the awning or use tie down devices. Use of such objects can cause serious damage to the awning that is not covered by warranty.

NOTICE When the awning is in the retracted (rolled up) position, shut off the power switch to avoid accidentally extending the awning. For safety, the power switch must be turned off before moving the RV.

Additional Cautions and Notices are included in the text for the proper operation of the awning.

OPERATION

The *Direct Response*[™] system detects awning motion caused by windy conditions. The sensor is located in the lead rail.

The system operates by gauging the motion of the awning's front edge (lead rail). When the motion exceeds the factory preset threshold the system retracts the awning.

NOTICE The Carefree auto-retract system is a premier electronic auto-retract system that provides protection against adverse elements; but no auto-retract system is a guarantee against severe or destructive weather; the effects of wind and rain on an awning are unpredictable and may cause severe damage to the awning and/or vehicle. If wind or extended periods of rain are expected, roll up the awning.

IMPORTANT NOTE: The auto-retract system is ON when the power is ON. The system is OFF when the power switch is set to OFF. If the power is shut off while the awning is extended, the awning is not protected by the auto-retract system.

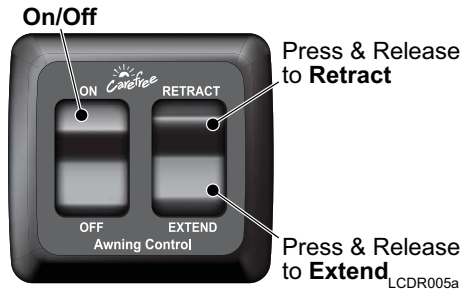

To Operate the Awning:

- Press the power switch to ON. When power is on, the Direct Response system is active and the manual controls are active. When power is OFF, all functions are disabled.
- To OPEN: Press and release the extend switch. The awning will open completely. To interrupt the awning motion, press and release the extend switch again. The awning will stop.
- To CLOSE the awning: Press and release the retract switch. The awning will close completely. To interrupt the awning retraction, press and release the retract switch again. The awning will stop.
- When the awning is in the retracted (rolled up) position, shut off the power switch to avoid accidentally extending the awning.

MANUAL OVERRIDE

If power to the vehicle is not available, the awning can be safely retracted using the manual override located on the idler (right) end of the case.

There are two configurations of the Freestyle RM. The original configuration is identified by the five (5) screws in the endcap. The current configuration has 1(one) screw in the endcap.

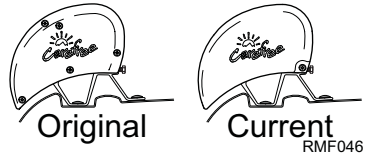

NOTE: This procedure cannot be used to extend the awning.

ORIGINAL CONFIGURATION

1. Remove the plug from the right endcap and save.
2. Insert a 3/8" socket drive extension and handle into the square drive hole inside the end cap.
3. Turn the handle clockwise until the awning is retracted.
4. Reinstall the plug

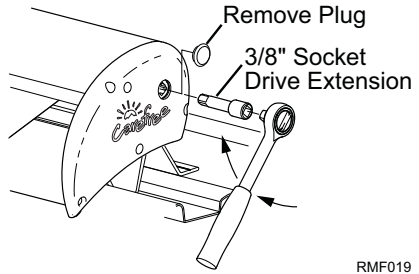

CURRENT CONFIGURATION

1. Remove the right outer endcap and save.
2. Insert a 3/8" socket drive extension and handle into the square drive hole inside the inner end cap.
3. Turn the handle clockwise until the awning is retracted.
4. Reinstall the outer cap.

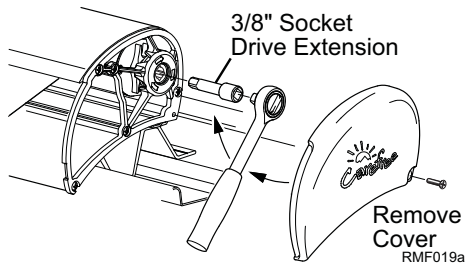

NOTICE After closing the awning with the manual override, the lead rail may move out from the case 1/4" -1/2". This is normal and the awning is secure for travel until power is restored or repairs are completed. Do not attempt to force the lead rail in with the override, serious damage can occur to the awning.

AWNING CARE

Maintaining a Carefree Awning is easy. Just follow these basic steps:

- Always operate the awning according to the instructions.
- Periodically check that the fasteners are tight. Tighten if necessary.
- Keep the awning fabric and arms clean.

FABRIC CARE

NOTICE Do not use oil based cleaners or any caustic, granulated, or abrasive type cleaners on your Carefree product.

1. One of the best ways to keep the fabric looking good and to delay the need for deep or vigorous cleanings is to hose fabrics off on a monthly basis with clear water. This practice will help prevent dirt from becoming deeply imbedded in the fabric. In most environments, a thorough cleaning will be needed every two to three years.
2. When it's time for a thorough cleaning, the fabric can be cleaned while still on the awning frame.
 - For Vinyl Fabric – Use a soft brush and warm water with soap.
 - For Acrylic Fabric – Use a stiff brush and warm water with soap.
3. When cleaning the fabric, it is important to observe the following:
 - Always use a natural soap, never detergent.
 - Water should be cold to lukewarm, never more than 100°F.
 - Air-dry only. Never apply heat to the fabric.
 - Always allow the fabric to dry thoroughly before rolling up the awning.

MILDEW

Mildew is a fungus growth that looks like dirt. Vinyl coated polyester fabrics are mildew resistant because of a chemical biocide in the vinyl coating. Under ordinary conditions, mildew will not appear. However, in areas where high temperature and humidity are common, mildew can be a problem and requires the material to be washed more frequently. Thoroughly rinse the fabric and allow to air dry before retracting the awning.

POOLING

When water collects on the top of the fabric, this is known as "pooling". This can occur during inclement weather or if a running air conditioner discharges over the awning. The water is dumped when the awning is retracted. It is recommended that if water accumulates; retract the awning in steps (8"-12") to dump the water. This will help prevent the fabric from stretching or distorting.

LEAKING

On vinyl canopies, side hems and poly cords are stitched in with a sewing machine. On occasion, this stitching may allow water to seep or leak through the stitches. This is normal and not a defect covered by warranty. Treat the seams with a quality seam sealer.

ARM NOISE

After a period of use, the arm knuckle joints may slide together slightly making a squeaking or squealing noise; this is normal and not a reason for concern. To reduce the sound, apply a few drops of multi-purpose oil (3-IN-1[®] ¹ or equivalent) on the knuckle joint seams. Operate the awning and repeat 3-4 times to allow the oil to penetrate into the joint.

ADJUSTING THE PITCH

The awning opens and closes with a steep pitch. On low profile vans, the leading edge of the awning may hit the top of the sliding door if the door is open while extending or retracting the awning. To prevent this, the lower limit of the pitch can be adjusted upwards.

NOTICE Use care to not raise the awning pitch to high. This can prevent the lead rail from closing properly. If in doubt, try closing the awning, if the lead rail does not close properly then lower the pitch.

1. Open the awning to access the adjustment screws located on the arm case knuckles.
2. Have a second person lift up on the lead rail to relieve the pressure on the adjustment screws.
3. Using a 4mm allen wrench, loosen the top screw. Turn the bottom adjustment screw clockwise to raise the lead rail; turn the adjustment screw counterclockwise to lower the lead rail.
4. When the pitch is set at the desired angle, tighten the top screw. Torque to 30 in-lbs.
5. Repeat for each arm. Ensure that the lead rail is parallel with the awning case.

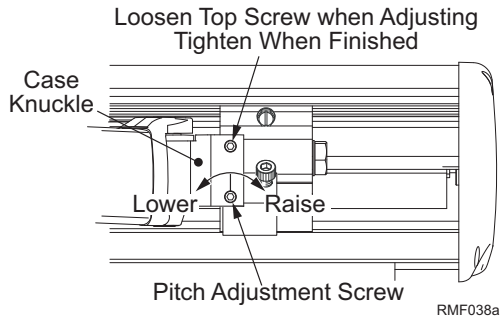

NOTE: The Freestyle RM lead rail self-adjusts to accommodate the pitch. No adjustment is required to the lead rail when the pitch is adjusted.

¹ 3-IN-1[®] is a registered trademark of the WD-40 company.

CAREFREE MAJOR PRODUCT LIMITED WARRANTY

Carefree of Colorado (hereafter referred to as Carefree) warrants to the first retail Purchaser that the Carefree Product is free of defects in material and workmanship within the terms and conditions as set forth in the warranty statement available online at www.carefreeofcolorado.com. Carefree's obligation under this warranty is limited to the repair or replacement, at Carefree's option, of any defective component with new or factory refurbished components.

OWNER MUST RETAIN THE ORIGINAL PROOF OF PURCHASE AND/OR HAVE THE PRODUCT WARRANTY REGISTRATION ON FILE AT CAREFREE FOR WARRANTY CLAIMS.

THIS WARRANTY IS NOT TRANSFERABLE.

For

- **Warranty Duration;**
- **Warranty Coverage and Exclusions;**
- **Warranty Terms of Coverage; and,**
- **Warranty Claim Procedures**

**Refer to publication
"Carefree Major Product Limited Warranty"
available online at
www.carefreeofcolorado.com**

Register your Carefree products on-line at www.carefreeofcolorado.com

Publications available on-line @ www.carefreeofcolorado.com:

070014-201 Freestyle RM Owner's Manual

070014-001 Freestyle RM Installation Manual

IMPORTANT NOTICE: It is strongly recommended that adjustments and repairs not described in this book be performed by trained technicians at your Authorized Carefree Dealer. Work performed by non-authorized persons or businesses may void warranty.

